



O/E/N 3572

AUTOMOTIVE POWER RELAY

FEATURES

- Direct PCB mountable
- High performance
- Suitable for various loads
- Heavy duty
- Immersion cleanable version available

APPLICATION

- Direction indicators
- Air-conditioning systems
- Body controllers
- Head lamp control
- Ventilation motors
- Security systems

TECHNICAL DATA FOR CONTACT SIDE

Areas of Application	Resistive / Inductive Load
Contact Configuration	: 1 Form A (1 NO), 1 Form C (1 CO)
Contact Material	: Silver Alloy
Contact Rating at 23°C - 12 VDC	: 45A/30 A
24 VDC	: 20A/10 A
Electrical Life in No. of Operations Min.	: 2×10^5
Mechanical Life in No. of Operations Min.	: 1×10^7
Contact Voltage Drop at 10 A (Max.)	: 50mV
Maximum Switching Current @ 12.8 VDC For 3 Sec.	: 100A

GENERAL DATA FOR COIL SIDE

Nominal Coil Power	: 1.60W (Approx)
Operate Time	: 10 milli Seconds (Typ)
Release Time	: 10 milli Seconds (Typ)

OPERATING CONDITIONS

Ambient Temperature	: -40°C to +85°C
Maximum Temperature	: 155°C
Dielectric Strength	
Between open contacts	: 500 VRMS
Insulation Resistance	: 100 MegaOhms Min. at 500 VDC, 25°C RH 50
Vibration Resistance	: 10-200Hz, 20-40g (Change in switching state not more than 10μS)
Shock Resistance	: 30g, 11mS (Change in switching state not more than 10μS)
Weight	: 25 gms Max.

WIRING DIAGRAM

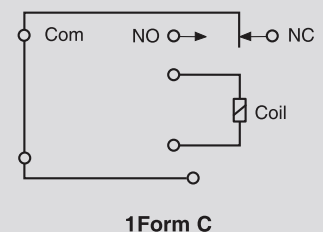
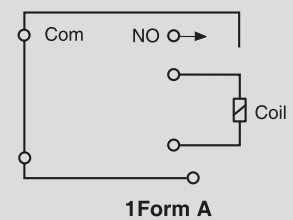

HOW TO ORDER

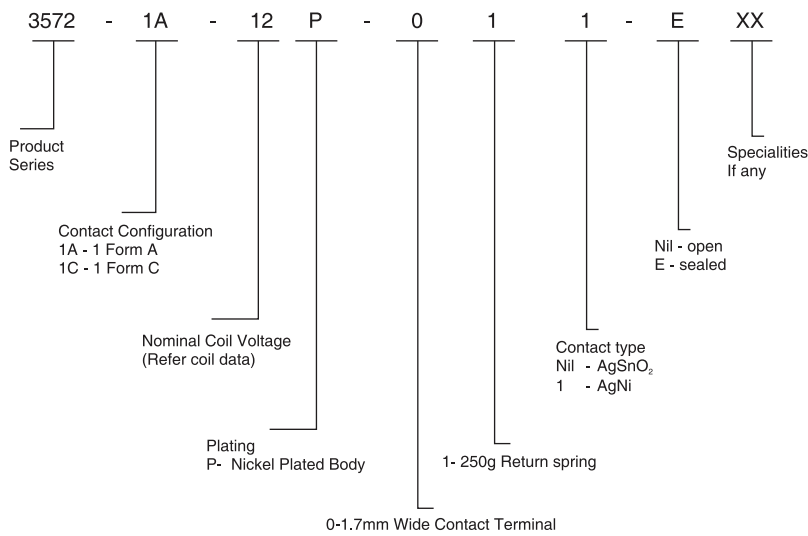

COIL DATA

Nominal Voltage VDC	*Pick-up Voltage VDC (Max)	Drop-out Voltage VDC (Min)	Coil Resistance Ohms ± 10%
06	3.3	0.6	19
12	8.0	1.2	90
24	16.0	2.4	360
48	32.0	4.8	1440

*Lower pick-up voltages available on request

DIMENSIONS

1 FORM C

Sealed Type

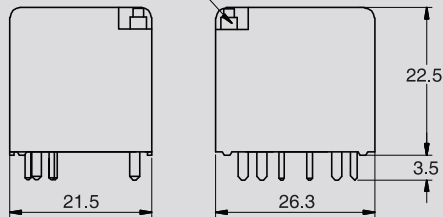

Open Type

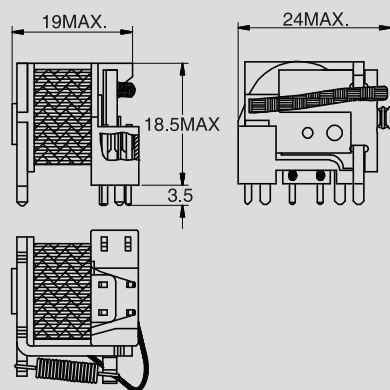

Note : Nip off pin may be removed after soldering and cleaning for ventilation

DRILLING PATTERN

PC Slot Layout

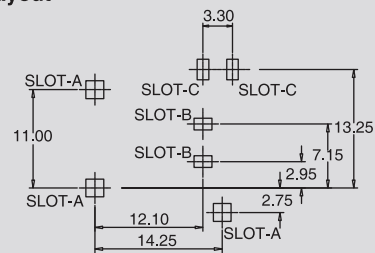

SLOT - A	SLOT - B	SLOT - C
SQ 2.0 ^{+0.1} _{-0.0}	SQ 1.3 ^{+0.1} _{-0.0}	1.3 ^{+0.1} _{-0.0} x 2.3 ^{+0.1} _{-0.0}

PC Hole Layout

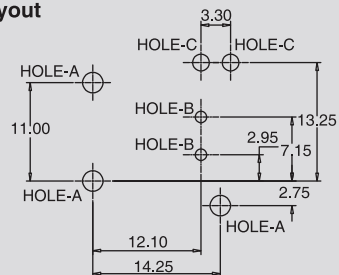

HOLE - A	HOLE - B	HOLE - C
∅2.30 ^{+0.1} _{-0.0}	∅1.3±0.1	∅1.9±0.1

Note : General Tolerance : ±0.1

AVAILABLE ON REQUEST

- For other custom solutions consult factory